

NARC & SP



"Horsemanship, Sportsmanship - Hand 'n Hand"

Rule Book

(last update-after January 2024 convention)

www.narcsp.com

Table of Contents

Bylaws..... Page 3
General Playday Rules.....Page 18

Single Events

Barrels Page 25
FlagsPage 26
Golfette..... Page 27
Poles..... Page 28
Pylons Page 29
Spur Page 30
Texas T Page 31
Straight Away Barrels.....Page 32
Hitch N GoPage 33
LarryettePage 34

Team Events (Year 2020 page35)

Cross Flags Page 36
Relay..... Page 38
Rescue Page 39
Ribbons.....Page 40
Harry Larry.....Page 41
Team Flags.....Page 43
Arena Pony ExpressPage 44
Drill & Parade RulesPage 49

Miss NARC&SP Queen Contest Rules Page 52
NARC&SP Wrangler..... Page 57
Rule Changes & NotesPage 59

Bylaws

Article I. Title, Object, Place of Business, Colors

Section 1. Title

This Association shall be known as the National Association of Riding Clubs and Sheriff's Poses and shall be at all times operated and conducted as a non-profit corporation.

Section 2. Objective

The purpose of this organization shall be to encourage the motto of "Horsemanship, Sportsmanship, -Hand 'n Hand."

Section 3. Place of Business

Business may be transacted at any place convenient to the members or officers.

Section 4. Colors

The NARC&SP colors are Gold, Black and White.

Article II. Members

Section 1. Membership

A. A member, as referred to in these bylaws. shall be any Riding Club, Sheriff's Posse, or other organized riding group (referred to in these Bylaws as "Member Clubs") and the individuals belonging to such Member Clubs. Its members may be residents of any state or territory.

B. Any business or concern may be an Associate Member with the approval of the Executive Board. It may enjoy all the rights and privileges of the Association except the right to vote and compete in the National Competition. The membership fee shall be established by the Delegates.

C. Any individual may be an Associate Member with the approval of the Delegates. The individual may enjoy all the rights and privileges of the Association except the right to vote and compete in National competition. The Delegates shall establish the membership fee.

Section 2. Discipline of Members

Members of the Association shall be admitted, retained and expelled in accordance with such rules and regulations as the Delegates may, from time to time, adopt. In the event a person has been refused membership in the NARC & SP for any reason, it will require a two-thirds (2/3) majority vote of the delegates at the next regularly scheduled delegates meeting to be accepted as a member at any time thereafter. In the event that a fight and/or severe misconduct occurs at any National Association function, the President, or the President's designate, will call a meeting with the Executive Vice President and the appropriate committee chairman, or the designates, at the function where the infraction occurred. In the event one of these individuals or the immediate family is directly involved in the incident the next Vice President will take their place on the committee. All three persons will have one (1) vote each to determine if a fight or severe misconduct occurred. If the vote is carried, the President will notify all members of the Executive Board and instruct the National Secretary to mail the first warning letter to all persons involved in the incident. The first letter will be notification of probation for one (1) year, unless the committee deems the offense severe enough to warrant full suspension as designated in procedures of second misconduct or third misconduct. If any or all of these persons are involved in second misconduct incident at a National Association function, the above procedures will be followed, and the second letter will be notification of suspension of participation from all National Association functions for a period of one (1) year. If any or all these persons are involved in a third misconduct incident at a National Association function, the above procedures will be followed, and the third letter will be notification of permanent suspension from the National Association. These suspensions will occur from the date of the infraction and the President must perform these duties within ten (10) days of the infraction(s). If there is no chairman at the function, such as the National Dance, the National Rules Committee chairman will attend the three-people meeting. All appeals must be made within thirty (30) days of notification and be made by written letter to the President. The President will address the matter at a regularly scheduled meeting or a special called meeting, within thirty (30) days of receipt of the letter, if requested, of the Executive Board. The parties involved may present why they should not have received the letter. When discussion is completed, the parties will be asked to leave, and a vote will be taken. This vote will be final and supersede all previous action taken by the three-man committee. These procedures are intended to manage incidents being considered extreme. They will be taken in addition to any actions taken by the appropriate committee at the time of the occurrence of the incident.

Section 3. Meeting of the Members

The regular meetings of the members shall be held in January and October at such time and place as may be fixed by resolution of the Delegates for the purpose of transacting business brought before the meeting. Notice of the regular meetings shall be given by mail to each

member in good standing, stating the time and place of such meeting, not less than fifteen (15) days prior to the date of the meeting. Each member District (2013) shall have selected (16) member persons to serve as Delegates. In all matters governed by the vote of the Member club Districts, each Member District in good standing shall be entitled to sixteen votes, but the Delegates must be present. You must be 15 years of age to be a voting member of the association.

Section 4. Term of Membership

Members must be approved (2022) by a District in good standing in the Association and shall be admitted to the Association upon completed (2022) application, accompanied by an initial membership fee. Membership shall begin, unless it is rejected by the Executive Board, upon receipt of a completed application.

Section 5. Districts

The Association shall be divided into Districts for the members' convenience. Any group of clubs wishing to form a District shall contact any Association officer. The Association officer and an Executive Board member shall meet with the applicants. The officer and Executive Board member shall bring the proposal to the Executive Board and, with two-thirds (2/3) majority vote of the Executive Board, authorize the District. Member Club and District Bylaws shall not be in conflict with the Bylaws of the Association. Each District shall be comprised of not less than two (2) Member Clubs nor more than five (5) Member clubs. Each District has the right to add additional clubs as Associate members without voting privileges. At such time a District has two (2) or more Associate Member Clubs, the Associate Member Clubs must organize a new District.

Section 6. Clubs

All Member Clubs, while in good standing, shall have equal rights, interests, and responsibilities with respect to the Association and its property.

Section 7. Membership Fee

The annual membership fee for the succeeding year, established by the Delegates, shall be due and payable on December 1, and delinquent May 15 (2012). A late fee of \$25. Per membership application will be imposed (2013). One (1) association membership fee paid per year, per family. A family is defined as being recognized by Texas State Law; a parent(s), legally married parents, domestic partnership residing in the same household (2013), their offspring, any child (ren) the parents are legal guardians of, and any children claimed as dependents on their income tax. A member or family may sponsor a child and include the children under their membership.

A child (ren) or sponsored child (ren) may only be added to one-member family (2010). The year a child reaches age 23 upon January 1st that child must pay their own (separate) membership fee. When a child of a membership marries, then upon the date of the marriage, a new family is formed, and they must pay their own membership fee.

Section 8. Social Media Policy (2014)

The main advantage of having a Social Media policy (2014) is to protect the NARC&SP, officers, chairpersons, Districts, clubs and members, otherwise known as the association and entities, if a person(s) acts unprofessionally on a Social Media site. Dislike of others and gossiping is part of human nature. The policy below is to allow everyone the advantage to make sure what is written, published, or shared does not in any way undermine the association or its entities reputation.

1. Disclosing any information that may harm you, the association, or its entities.
2. Certain activities on the part of the association and entities may not be public knowledge due to confidentiality or preplanning purposes. Posting of hearsay on a social media website about the association or its entities can be harmful or impair the work of the association.
3. Harassing, demeaning or creating a hostile environment within the association and its entities in a social media forum can be disruptive, malicious and harmful.
4. Disrupting the smooth and orderly flow of the association either directly or indirectly by disclosing confidential or proprietary information on social media.
5. Harming the goodwill and reputation of the association or its entities within a social media forum.
6. Poor social media tends to put in place the doubt of reliability, trustworthiness, or sound judgment of the person(s) who is the subject of the information; or member(s).
7. Do not ignore copyright laws. Cite any reference sources accurately. Remember the prohibition against plagiarism applies online.
8. Do not use any NARC&SP logos or trademarks without permission from the Executive board. The absence of explicit reference to a particular site or association does not limit the extent of the application of this policy.
9. In the area of social media (print, broadcast, digital, and online), members may use such media in any way they choose as long as such use does not produce the adverse consequences noted within this articles section. For this reason, the NARC&SP has adopted the policy for members to apply in their use of social media both as a member and or an officer.
10. A most prudent course of social media action should always be taken regarding the association and its entities. Any member(s), clubs, or districts deemed responsible for such issues will be subject to counseling and or action taken according to the NARC&SP Bylaws; Article II, Section 2, Discipline of Members.

Article III. Delegates

Section 1. Number of Delegates

There shall be (2013) sixteen (16) Delegates from each District Member Club. The business and property of the Association shall be managed and controlled by the Delegates and an Executive Board. Each District Member Club can either elect or appoint Delegates. Each Delegate attending a meeting must bring a letter of identification, signed by two (2) officers of the District Member Club, which the delegate represents, designating that person as a delegate. Proxy votes are not acceptable.

Section 2. Identification of Delegates

In the event a letter of identification is not available at any meeting of the Delegates, two (2) officers of the (2013) District Member Club in question may verbally verify the eligibility of its Delegates.

Section 3. Special & Emergency Meetings

A. Special meetings of the Delegates may be held at such time and place as may be designated by the President or twenty percent (20%) of the Delegates. Written notice of each special meeting, including the objective or objectives thereof, shall be given all (2013) Districts Member Clubs not less than fifteen (15) days prior to the date of the meeting.

B. Emergency meetings may be called at the request of fifty percent (50%) or more of the elected Association Officers and Standing Committee Chairpersons. Notice written or verbal, of each emergency meeting, including the objectives thereof, shall be given to all (2013) Districts Member Clubs forty-eight (48) hours prior to the meeting.

Section 4. Quorum

At any meeting of the Delegates held in accordance with the foregoing provisions of the notice, the Delegates attending each meeting shall constitute a quorum.

Section 5. Meeting Chairman

Any officer of the Association may call the meeting of the Delegates to order and may act as Chairman of such meeting, precedence being given as follows: President, Executive Vice President, 1st Vice President, 2nd Vice President, Secretary, and Treasurer. In the absence of all such officers, the Delegates present may elect a Chairman. The Secretary of the Association shall act as a Secretary of the meeting in the absence of the Secretary; the Chairman may appoint a temporary Secretary.

Section 6. Removal of Officers and Committee Chairpersons

The Delegates shall have the power to remove from office any Association Officer or Committee Chairperson by a two-thirds (2/3) majority vote at a duly called Delegates meeting.

Section 7. Discipline

The Delegates shall have the power to place on probation, suspend, or expel from Association membership a District, Member Club, or individual member of such Member Club by a two-thirds (2/3) majority vote at a duly called Delegates meeting.

Article IV. Officers and Duties

Section 1. Officers

A. Officers and (Oct 2019) Committee Chairpersons of the Association shall be elected by secret ballot by majority vote of the Delegates at the October meeting. The term of office shall be for one (1) year, beginning January 1st following the election. Officers must be of high morals and possess leadership qualities. Officers and Chairpersons must conduct themselves in an appropriate professional manner when conducting NARC&SP business. Profane language is not allowed. Violating the by-law may be cause for discipline and or removal from office. They must be a member in good standing of a Member Club and of the National Association. A new officer or committee chairperson may start setting up transition meetings in November and December.

B. The officers shall be a President, Executive Vice President, 1st Vice President, 2nd Vice President, Secretary, Treasurer, and such other officers as may be authorized by the Delegates.

C. No officer (2022 remove; committee chairperson) can be elected to the same office for more than three (3) consecutive years.

Section 2. President

A. The President shall be the chief executive officer of the Association, shall preside at all meetings of the Delegates and Executive Board, and shall be an ex-officio member, with voting rights, of all committees except the Nominating Committee. The President shall be responsible for the enforcement of the Bylaws and rules of the Association and has the authority to call an Executive Board meeting for investigation of a violation of these Bylaws and rules.

B. The President may create and empower committees other than Standing Committees, as the President deems necessary.

C. The President will appoint a Parliamentarian.

Section 3. Executive Vice President

In the absence of the President, the Executive Vice President shall have the power and shall perform the duties of the President. The Executive Vice President will perform such other duties that may be prescribed by the President or the Executive Board. The Executive Vice President shall be an exofficio member, without voting rights, of all committees, except the three-man committee.

Section 4. 1st Vice President

The 1st Vice President shall assist the President in the President's duties, be in charge of the National Trail ride, and will assist in collecting money at the gate for National Association functions as assigned by the President.

Section 5. 2nd Vice President

The 2nd Vice President shall assist the President in the President's duties, help coordinate the Handbook and the Directory with the Publication's Chairperson and will assist in collecting money at the gate for National Association functions as assigned by the President.

Section 6. Secretary

The Secretary shall (10-2019) shall provide notifications to the board of all planned Executive Board Meetings. The secretary shall keep the minutes of all Delegates and Executive Board Meetings. The Secretary shall be custodian for the safekeeping of all documents and records of the Association customary to this office. The Secretary shall also be responsible to see that the records are kept and maintained for the National Playday Finals.

Section 7. Treasurer

The Treasurer shall receive and be responsible for all moneys of the Association. The President must approve all disbursements by the Treasurer. All checks must bear two (2) authorized signatures. All disbursements shall be regulated by the budget as approved by the Delegates. The Treasurer shall account for all income and disbursements by itemized statements in detail to each regular meeting of the Member Clubs and to the Executive Board upon demand. The Treasurer shall submit a monthly financial statement to the President and a quarterly financial statement to each District. The Treasurer is responsible for supplying rosters to the Secretary and Publications Chairperson.

Section 8. Parliamentarian

The Parliamentarian shall advise the Chair on parliamentary procedure according to Robert's Rules of Order.

Section 9. Executive Board

A. Composition of Executive Board

There is hereby created an Executive Board consisting of the Past President, one (1) Executive Board Member elected by each District, the District Presidents, the Chairperson of each Standing Committee, Miss NARC & SP and the Wrangler (2010). If a District President is already on the Executive Board, the District President may have a representative in the District President's place.

B. Duties and Powers

1. When a meeting of the Delegates is not in session, the Executive Board shall have and exercise all the duties and powers vested in it by these bylaws.
2. The Executive Board will formulate and develop new plans and ideas and present them in the next Delegate meeting.
3. The types of awards, trophies, plaques, etc. for the National Playday Finals awards are to be decided by the Executive Board at the March Executive Board meeting. Any donations made towards awards for any NARC&SP function are to be made prior to said function and said donation received prior to said function.
4. Members of this Board shall have the right to vote in the meetings of the Delegates.

C. Meetings

1. The Executive Board shall meet whenever and wherever called by the direction of the President or twenty (20%) percent of the Board acting jointly.
2. In the event of a called meeting, the (10-2019) Secretary shall give ten (10) days written notice to each member.
3. The Board may act by written ballot without convening in a meeting.

Section 10. Vacancies

- A. In the event of a vacancy in the office of the President, the Executive Vice President shall fill the office.
- B. In the event of a vacancy in the office of the Executive Vice President, the Executive Board will elect one of the Vice Presidents to fill the office.
- C. In the event of a vacancy in one of the offices of the Vice President, Secretary, or Treasurer, the Executive Board will elect a successor.

Section 11. Contracts

The written contracts of the Association shall be executed by the President or the Executive Vice President and approved by the Executive Board.

Article V. Auditing, Bonds, Moneys

Section 1. Auditing

This Association shall conduct its affairs on a calendar year basis, beginning January 1st, and ending on the last day of December. The Treasurer shall submit an itemized statement of income and expenditures at each meeting of the Delegates. The Delegates may require an audit of the books at the expense of the Association, using an accountant who is not a member of the Association.

Section 2. Surety Bonds

The President and all other officers or employees of the Association who may handle funds of the Association shall give a surety bond to be furnished at the expense of the Association, for the faithful discharge of their duties. The Treasurer must bond these officers and employees in the amount of \$2,000 each before they take office on January 1st.

Section 3. Moneys and Accounts

The retiring Treasurer shall account for all moneys and audited accounts by the January delegates meeting. The Treasurer shall be liable for any funds held not accounted for. Any Member Club or District owing a past due account to the Association shall be suspended and shall not enjoy voting or participation privileges until the account is settled. An account shall be considered past due thirty (30) days after the billing date. Should the association have any returned checks the payer must pay the face amount of the check plus \$35. for bank fees. All returned payments and fees must be paid with cash, money order, or cashier's check. If the payer does not respond to repayment requests the returned check will be turned over to the District Attorney's office for collections (2009).

Section 4. Due Date of Moneys

All moneys for National events must be in the hands of the Treasurer ten (10) days prior to the National event, excluding Queen's functions, Parade & Drill functions and Pony Express functions (2012). If you are to be a delegate, your membership dues must be in ten (10) days prior to any convention (2011).

Section 5. Scholarship

The National Association shall award scholarship(s) each year to an Association member(s) graduating as a high school senior, who makes application for the scholarship(s), in an amount set by the delegates in the budget approved by the Delegates and distributed by the scholarship committee at their discretion.

Should a scholarship recipient dropout of the semester, in which the NARC&SP funded any dollar amount the money would need to be reimbursed to the NARC&SP within six (6) months.

The selection of the qualified recipient will be determined by the criteria established by a scholarship committee. The scholarship must be used within five (5) years after it is awarded. The money will be paid directly to the educational institution chosen by the recipient, upon receipt of an invoice (2021). If the chosen recipient refuses the scholarship, the committee will offer it to the next qualified applicant. If there is no qualified recipient available, the scholarship will not be awarded that year. Only applications from Association members, in good standing, will be considered for this scholarship each year.

The National Association shall establish a scholarship fund to be invested in appropriately, secure financial instruments, the earnings from which shall be used to fund a scholarship or scholarships as the Association delegates shall determine from time to time.

Article VI. Standing Committees

Section 1. Committee Composition

- A. The Chairperson of each committee shall be elected by secret ballot by the Delegates at the October meeting.
- B. Each District shall provide one (1) member to all Standing Committees.
- C. A Delegate meeting is required to remove a chairperson.
- D. Any committee chairperson that handles money (such as gate, fundraisers, auctions, etc) must turn in said money to the National Treasurer along with an itemized detailed report signed

by the Chairperson and the National Treasurer. (2010) All monies are due within 14 days of the end of the function.

Section 2. Quorum

The number of members attending any committee meeting shall constitute a quorum.

Section 3. Arena Pony Express Committee

This committee is charged with the responsibility of making the rules for the Arena Pony Express activities of the Association. All rules made by this committee shall be presented to the Delegates for final approval.

Section 4. deleted--2007

Section 5. Parade and Drill Committee

This committee is charged with the responsibility of making the rules for the Parade and Drill activities of the Association. All rules made by this committee shall be presented to the Delegates for final approval.

Section 6. Nominating Committee

A. This committee shall make nominations for the National Officers and Standing Committee Chairpersons.

B. The committee shall elect a slate in time for publishing in the September issue of the "Horse Tales". Cutoff date for getting names on the nominating list shall be the date of the National Playday Finals.

C. These selections shall be based on the person's ability and each candidate must meet the minimum requirements for the respective office as specified in Article IV, Section 1, Paragraph A of these Bylaws.

D. Any Member Club may submit to the committee a nominee for any office.

E. The final slate of candidates shall be submitted by this committee to the Delegates at the October meeting.

F. The floor shall be open to nominations. The opening of the floor to nominations shall be for each office separately. Any person making a floor nomination must have the candidate's prior consent.

G. Any Person being nominated as any National Officer or Committee Chairperson must have held a previous office on a Member Club or District level.

H. The nominating committee shall furnish Immediately, in writing, to each officer candidate and each committee chairperson candidate a list of their duties and responsibilities.

Section 7. Playday Rules Committee

This committee is charged with the responsibility of making the rules for the Playday activities of the Association. This committee will be in charge of making certain that all equipment and the arena are ready for the National Playday Finals. All rules made by this committee shall be presented to the Delegates for final approval. The interpretation of the rules by the Rules Committee shall be binding. In the event of a National Finals rain date, the Rules Chairperson has the authority to rearrange the running order to accommodate family members riding the same horse.

Section 8. Miss NARC & SP Queen Committee

This committee is charged with the responsibility of making the rules for the Miss NARC & SP Queen contest. The Miss NARC & SP Queen Committee Chairperson cannot hold office while their daughter is running for or holding the office of Miss NARC & SP Queen. All rules made by this committee shall be presented to the Delegates for final approval.

Section 9. Publications Committee

This committee is charged with the responsibility of publishing the Association's "Horsetales" each month, the Handbook (Rulebook), and the annual Directory. The rule book printing cost will come from the General Fund (2015). Each member family with paid membership by March 15 shall have access (2017) to the rule book (2015).

Section 10. Budget and Finance Committee

This committee shall submit to the Executive Board and Delegates at the January meeting the detailed budget of the proposed and anticipated income and expenditures for the forthcoming year of the Association. Upon its approval or modification thereof, the budget becomes binding upon the offices of the Association.

Unless otherwise approved by two-thirds of the Executive Board, the amount of any budgeted item may not be exceeded by more than ten percent (10%) and expenditures for nonbudgeted items must be approved by the Executive Board as required and may not exceed ten percent (10%) of the total budget. A committee may not spend more than the amount made by the committee. The President, Treasurer, and all Committee Chairpersons shall be on this committee. This committee shall be responsible for the arrangements associated with the

January and October Conventions and for obtaining bids for the National Playday Finals Awards.

All convention money or moneys from Club Delegates, District Presidents, District Executive Committeemen, Committee Chairpersons, and National Officers are due to the Budget and Finance Chairperson ten (10) days prior to all conventions. All lunch reservations must be made ten (10) days prior to the convention. The Budget and Finance chairperson will furnish the National Secretary with a list of delegates scheduled to attend 5 days prior to the convention, based on monies paid. All districts and clubs must use the form provided by the Budget and Finance committee for their delegates' letter. It is up to the committee's discretion for choosing the location for the January convention.

Any donations made toward awards for any NARC & SP function are to be made prior to that function. The donation must be received prior to the function.

Section 11. Historian

The Historian is responsible for maintaining all historical documents, including pictures, pertinent to the Association. A scrapbook for each year will be created for the Association. This committee shall be responsible for gathering all necessary information to make a complete history book for the National Association for each year. The committee reserves the right to edit this information. Information will cover the period from January to December. Each District shall submit the history they wish to include in the scrapbook from their annual activities.

The following information is to be included:

- A. Names and pictures of the National Officers and Miss NARC&SP
- B. Information from the January and October Conventions.
- C. Pictures and information from each Standing Committee covering the activities for the year.
- D. Pictures, names of the District Officers, the District Queens and information on District activities.
- E. Each club will submit, through their District Historian, the information they wish to include from their year's activities. This should include pictures and names of officers and club sweethearts.
- F. Issues of the Horsetales' for January through December.
- G. Copy of the Handbook for the year.
- H. Copy of the Directory for the year.
- I. Any other information the committee deems necessary to complete the year's history.

Section 12. Scholarship Committee

This committee is charged with selecting recipient(s) for the annual NARC & SP scholarship. The members of this committee shall not hold office while they themselves or their child is eligible for this scholarship.

Section 13. Wrangler Committee (2010)

This committee is charged with the responsibility of making rules for the NARC&SP Wrangler contest. The Wrangler Committee Chairperson cannot hold office while their son is running for or holding the office of Wrangler. All rules made by this committee will be sent to the delegates for final approval.

Section 14. Vacancies

In the event of a vacancy in the office of a National Committee Chairperson, the Executive Board will elect a successor.

Article VII. Operating Procedures

Section 1. Meeting Times of Committees

All Standing Committees shall meet in January and October each year and submit their recommendations to the Delegates.

Section 2. Reimbursements of Host District

In all Association functions, the Host District shall be reimbursed - by presentation of a bill -for the cost of water and gasoline (2012). No National function may be held by an individual Member Club.

Section 3. Selection of the National Playday Finals Site

The Executive Board shall approve the selection of sites for the National Playday Finals before presentation to the Delegates for final approval.

Section 4. General Registration Fee

Any member of the Association who attends or participates in any of the National functions will be required to pay the General Registration Fee to be set by the Executive Board.

Section 5. Making Arrangements

The Executive Board shall work through, and with, the Host District in making arrangements.

Section 6. Voting on Rule Changes

Changes in Rules pertaining to any Playday rules, Miss NARC & SP rules, Parade and Drill rules, Arena Pony Express rules and Wrangler rules (2010) can be brought up at both meetings, January and October, but voted on at the January meeting only.

Section 7. Functions

A National Association sponsored function begins when the first person arrives at the site and ends when the last person leaves the site. The October Convention Dance is the only sponsored National function allowing the consumption of alcoholic beverages during the function.

Section 8. Limits on Attendance

The National Association reserves the right to refuse anyone admittance to or participation in any National Association sponsored function for any just cause.

Article VIII. Meetings

Section 1. January Meeting

There shall be a January meeting of the Delegates and all Standing Committees at which time all necessary business will be transacted.

Section 2. October Meeting

There shall be an October meeting of the Delegates and all Standing Committees at which time all necessary business will be transacted, and the election of National Officers and Standing Committee Chairpersons will be held.

Section 3. Representation of Districts

At all National Association business meetings and committee meetings, an individual can only represent the district through which their National dues have been paid.

Article IX. Amendments

Section 1. Alteration of Bylaws

Only the Delegates shall have the power to make, amend, and repeal the Bylaws of the Association by a vote of a majority of the Delegates present at any regular or special meeting of the Delegates.

Section 2. Time of Voting on Amendments

All recommended amendments to the Bylaws of this Association, made by the Executive Board, shall be in abeyance until the next meeting of the Delegates.

Playday Rules
Standard Arena Dimensions

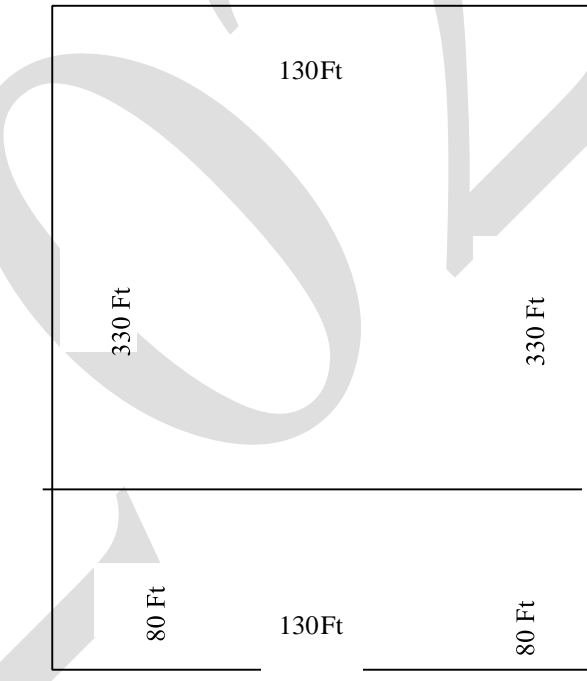

The arena should be totally enclosed.

General:

The following rules have been adopted by the National Association of Riding Clubs and Sheriff's Posses and will govern National Events. Any questions presented to the National Playday Rules Committee must be by a District Officer in which the question arises. Districts will run as close to National Rules as possible.

1. Participants in the single events shall be divided into fifteen classes (2004):

Classic Men	Classic Women
Super Senior Men	Super Senior Women
Senior Men	Senior Woman
Intermediate Men	Intermediate Women
Junior Boys	Junior Girls
Pee Wee Boys	Pee Wee Girls
Mini Pee Wee Boys	Mini Pee Wee Girls
Assisted (2014)	Oldies & Goodies (2021)

Oldies & Goodies (2021)

A non-competitive class, men and women mixed that have reached the age of 68 years before January 1 of the current year. All awards to be donated.

Classic Division

A contestant that has reached 55 years of age or older before January 1st of the current year. The rider has the option to ride in the Super Senior class if desired.

Super Senior Division

A contestant that is 40 - 54 years of age before January 1st of the current year.

Senior Division

A contestant that is 24-39 years of age before January 1st of the current year.

Intermediate Division

A contestant that is younger than Senior but has reached (2009) 16-23 years of age before January 1st of current year.

Junior Division

A contestant that is younger than Intermediate but has reached (2009) 11–15 years of age before January 1st of the current year.

Pee Wee Division

A contestant that is younger than Junior but has reached (2009) 7-10 years of age before January 1st of the current year.

Mini Pee Wee Division

Those contestants younger than Pee Wee or are (2009) 6 years of age and younger before January 1st of the current year.

Assisted Division

This class is open, non-competitive and will receive participation awards at National Playday Finals. The person assisting (2014) the rider must be 15 years of age or older. No times will be given after the run; the rider either succeeds or fails. The patterns will be shortened. The horse rule does not apply to the Assisted Division. An Assisted Rider (2018) has the option to move up to the appropriate age group as desired. If they move up at a National function, they must remain in that age group the remainder of the year.

A Mini Pee Wee has the option to ride as a Pee Wee. A Pee Wee has the option to ride as a junior. A Junior has the option to ride as an Intermediate. An Intermediate has the option to ride as a senior. A Senior cannot ride as a Super Senior. A Super Senior has the option to ride as a senior. This decision must be made at the first of the year. A rider may not jump two divisions until age permits. The classic class has the option to ride in the Senior, Super Senior or Classic Class. In the event (2018) there is only one person in a class at National Finals they have the option to move up to the next age group.

2. Participants shall be present at the time of the call for any event. Three calls will be made. If the participant is not ready to ride on the third call, that participant will be disqualified. Once a rider has entered the arena prepared to ride and an equipment failure occurs prior to their crossing the start line, that person will be offered a reasonable amount of time to make any needed repairs.
3. Scoring points to determine winners will be as follows: 5 points for first place, 4 points for second place, 3 points for third place, 2 points for fourth place, 1 point for fifth place. Awards won at National Finals will be made available for pick-up at the October convention and the following January convention of the following year. If awards are not picked-up by noon at the January convention, they will be donated back to the NARC&SP at the discretion of the Budget & Finance Committee.
4. The start and finish line designate the beginning and ending of each race. It may be marked by a line. The start and finish line may be marked at the discretion of the rules committee.
5. All races start with a signal from a flagman unless an electric timing device is used. The time shall start and stop when the horse's nose reaches the start and finish line.
6. Judges may disqualify riders for profane language. The Rules Committee may disqualify any individual for profane language, disorderly conduct and/or use of alcohol or illegal substance.

Threats of violence will be considered severe disorderly conduct. The rules committee can, with a two-thirds (2/3) majority vote, disqualify any individual for the remainder of the day, disqualify for the entire function (total loss of points), and/or require them to leave the premises for the remainder of the function.

7. A horse may not be struck with playday equipment at any time. Striking a horse with playday equipment will disqualify the rider for the event in which the rider is participating.

8. The rules committee will act on any disorderly conduct inside or outside of the arena.

9. While each rider is competing, the next rider must be prepared for competition or the three (3) out count will be in effect. With the one riding and at least one in the gate. (2021) When the competing horse is under control and heading toward the exit gate, the next contestant may enter the arena, with or without assistance. There will be a gate judge to regulate riders coming into the arena. The gate judge will enforce this rule at the National Playday Finals.

10. Western equipment is compulsory, except for the safety equipment. For example: no bareback rigging or pads may be used; however, barrel racing saddles built on Western stock saddle type will be permitted. All riders must wear a shirt and pants, or shorts (2022).

11. The judges may disqualify an unmanageable horse for reasons of safety.

12. A horse may be ridden only one time in each class or event except for a horse used by a family. Two brothers or sisters may ride the same horse in all events, but a horse may not be used in one event in the same class or event, unless the two riders are of the same immediate family. The immediate family will include a married child and that child's family, grandchildren, a niece or nephew in good standing with the National Association may ride their Aunts' or Uncles' horse. A sponsored child under a family membership is also considered as family. (2010) Co-ownership does not constitute a family. In case of an infraction of the horse rule, all riders after the first rider will be disqualified and lose their points. In the Rescue Race where only one horse is being ridden, the horse may be ridden by either team partner as long as the horse is not ridden by a third party other than a member of the owner's family.

13. To share a horse the persons must adhere to the family section of Article 2, Section 7.

14. At any time, if a rider falls or becomes dismounted in any race that person is disqualified.

15. (2021) omit rule about administering medications to horses.

16. In the event of a tie at playday finals, the rules committee will determine the tiebreaker. (2008) When breaking ties, the original horse must be ridden (2021) unless the Rules

Committee determines an original horse is unfit to compete. A substitute horse may be used. The substitute horse must meet the conditions of the horse rule. The running time of the subsequent run may not be more than 2 seconds slower than the previous run (2017).

17. Each district is eligible to send an unlimited number of participants in each class, as qualified by the district to National Playday Finals. All riders will ride in a randomized order in each event.

18. Each district must hold a minimum of two (2) complete point playdays to send riders to the National Playday Finals.

19. The Secretary of each district shall send a list of qualified contestants eligible to participate in the National Playday Finals before any contestant can be registered from that District.

20. In reference to the National Playday Finals, all point inquiries must come through the District Secretary of the District of the person making the inquiry. The District Secretary will, in turn, inform the persons making the inquiry as to points. Any questions pertaining to the National Secretary books must go through the District Secretary.

21. A contestant can represent only one district at the National Playday Single Event (2012) Finals.

22. All equipment used at the National Playday Finals shall be inspected and approved by the National Playday Finals Rules Committee. All fifty-five (55) gallon metal barrels must have manufactured protective pads.

23. The recommended equipment used at the National Playday Finals will be of the following colors:

Barrels: Blue or combination of three colors with blue predominant.

Batons: Black, green, or white

Flag Sticks: White or neutral with different color material for the flag. The flag color must be similar or the same in color and/or same design on the flag.

Poles: White

Golf Balls: White

Pylons: of an appropriate color orange to be visible against arena dirt.

It is recommended that the Districts use the colors set forth in this rule. Personal equipment does not have to be left for others to use. The start and finish line will be marked at the discretion of the rules committee.

24. Pre-registration of contestants to the National Playday Finals through the District Secretary will be required. Registrations must be into the Association Secretary by the Queen's Playday or no later than two weeks prior to the National Playday Finals. The contestant sheets are final and cannot be changed, except for moving up listed alternates.

25. Use of hot shots is not permitted.

26. When meeting with another association, the Rules Committeeman has the authority to negotiate with other association Rules Committeeman on rule changes.

27. Any event can be published in the Rulebook if submitted and approved by National Rules Committee.

28. Failure to correct the pattern, in any event as diagrammed in the rulebook, is a disqualification.

29. All measurements are to be made from the center of the barrel, and all barrels are to be painted, except for plastic ones.

30. The time limit on protests at the National Playday Finals shall be 30 minutes after the last rider of each class, in each event.

31. Once a rider starts his/her pattern, no assistance will be allowed by anyone inside the arena who is on the event side of the Start/Finish line.

32. All protests must be accompanied by a \$50. protest fee at the National Playday Finals. If the protest is won, the money will be returned. If the protest is lost, the money will belong to the National Association. The class or individual re-riding due to a protest shall ride at the end of the event. Videos will not be allowed as a part of the protest (2022).

33. In the event a class is re-run, the riders have the option of keeping the first time run or they may run again.

34. In the event a protest is made and upheld where the event is set up wrong or the judge had interfered with a rider only the person or persons involved have the option of a re-ride.

35. At the judge's discretion, a rake can be used to smooth the arena in any event, to help prevent unsafe conditions. If conditions are unsafe, in any event, the judge has the option of calling for the arena to be dragged.
36. No class or event shall start after 2 a.m. on Sunday. Any unfinished event will resume on Sunday morning. Any event started after 12:00 a.m. will be run in reverse order – Classic Men, Classic Women, Super Senior Women, Super Senior Men, Senior Women, Senior Men, etc.
37. In the event the National Playday Finals is rained out, the Executive Board and the Host District will have the authority to decide what should be done.
38. The determination of how an event is to be set up at the National Playday Finals will be decided by the Rules Committee and the host District Rules Chairman.
39. (2021) No uninspected or unlicensed motorcycles and no ATV's, bicycles, hover boards, scooters, etc. will be allowed at the National Finals Playday near the designated warm up areas and where horses are entering and exiting the arena while events are taking place.
40. (2009) the exit judge rule has been deleted.
41. If a barrel, pole, or pylon is either flipped or hits the ground, the appropriate penalty will be imposed.
42. At National Finals if a rider starts an event and subsequently stops the clock, that rider may not reride the event to correct the horse.
43. The President, Miss NARC & SP, the Wrangler (2010) and their families automatically qualify to go to National Finals and are not counted in the five positions that the district can send. They will be rotated as a district would rotate for running positions.
44. Rules Committee will decide based on the best interest of the arena conditions and attendance on whether to use one arena or two no matter who hosts finals (2011).
45. Peewee and under riders that get a rerun due to technical problems will be moved to the end of the class unless their parent or responsible party are immediately available to make the decision for the child. The parent or responsible party will be given the three (3) calls to make the decision.
46. (2013) Should the association want to change an event it will be replaced by a similar type. event ie. hand event.

47. (2022 & 2023 & 2024) The six single events to be ran at National Finals playday will be selected from the current rule book by the rules committee at the January convention.

Single Events

Barrels

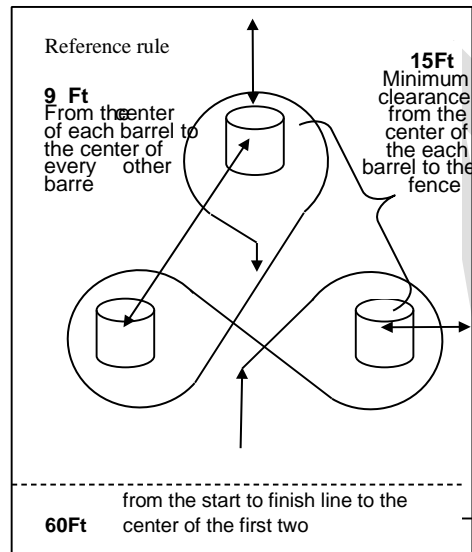

****Riders may start at either the left or right barrel****

Description of Race

The rider will cross the start and finish line, make a three hundred sixty (360) degree turn around the first barrel, go across the arena, make a three hundred sixty (360) degree turn around the second barrel, and then make a 360 degree turn around the third barrel, returning between the first and second barrels; and crossing the finish line. This is known as a cloverleaf barrel pattern. The rider may run either a right or a left pattern.

Equipment

Three (3) fifty-five (55) gallon barrels placed in a triangular pattern, ninety (90) feet apart, forming a cloverleaf pattern. The first and second barrels are sixty (60) feet from the start and finish line. Measurements should be taken from the center of each barrel. The barrels must be a minimum of fifteen (15) feet from any arena fence.

Judges

As many judges as necessary to observe the rider's pattern and to set the barrels in the proper place, if they are knocked over.

Penalties

A five (5) second penalty will be added to a rider's time for knocking over a barrel.

Disqualification

Breaking the pattern.

Flags

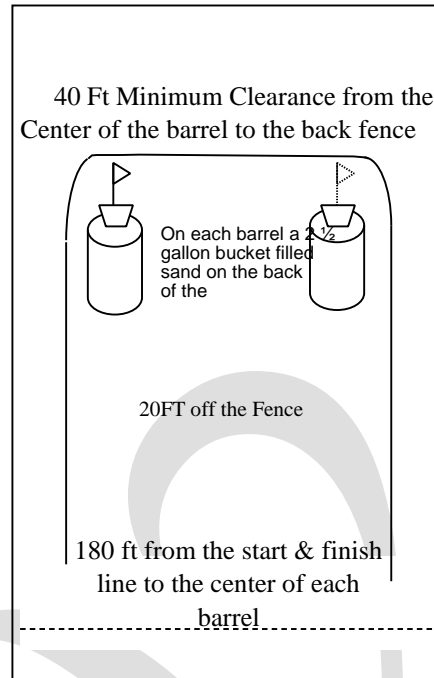

****Riders may start on either the right or left side****

Description of Race

The rider races across the start and finish line to the first barrel and picks up the flag. The rider continues to the second barrel where the flag is placed on top of or in the second bucket as the rider goes around the outside of the barrel. The rider may circle either or both barrels during the run (2010). The rider continues across the start and finish line. It is not necessary that the rider stick the flag in the sand, but the flag must remain in or on the bucket. The rider may ride either a right or a left pattern.

Equipment

Two (2) fifty-five (55) gallon barrels placed one hundred eighty (180) feet from the start and finish line. The fifty-five (55) gallon barrels are placed twenty (20) feet from the fence line. The fifty-five (55) gallon barrels must be a minimum of forty (40) feet from the end of the arena. Two (2) two and one-half (2 1/2) gallon plastic buckets without obstructions, such as bails or ears, each completely filled level with (2008) arena dirt, to the top of the bucket, and one (1) put on top of each of the fifty-five (55) gallon barrel at the back edge, which is the edge furthest away from the start and finish line. One (1) six (6) inch by eight (8) inch rectangular flag. The flag sticks are fourteen (14) inches long and one-half (1/2) inch in diameter with a three (3) inch marker on the flag stick to indicate how deep to put the flag down in the dirt. The flag stick must be beveled (2010). The flag is placed in the center of the first bucket, which is determined

by the pattern direction run by National Association of Riding Clubs & Sheriff's Poses the contestant. There should be sufficient quantities of flags to keep the game moving.

Judges

Two (2) judges, one (1) at each barrel. In addition to judging, they are responsible for placing the flag in the proper bucket, in the proper position.

Penalties

There will be a five (5) second penalty added to the rider's time for knocking over the first bucket or barrel.

Disqualification

Dropping the flag on the ground or barrel.

Failure to deposit the flag on top of the second bucket.

Knocking over (2022) the second bucket or barrel.

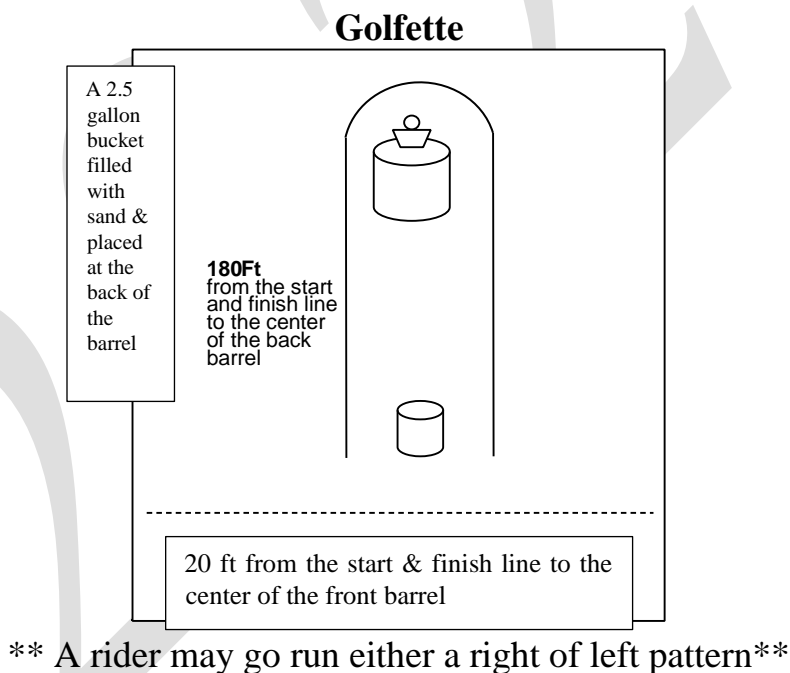

Description

The rider races to the barrel, picks up the ball while turning or circling the barrel, returns to the barrel nearest the finish line, deposits the ball in this barrel, while passing by or circling it before crossing the finish line. The rider may run either a right or left pattern.

Equipment

One (1) fifty-five (55) gallon barrel placed 180 feet from the start and finish line.

One (1) two and one half (2-1/2) gallon metal or plastic bucket without obstructions, such as bails or ears, completely filled level with (2008) arena dirt, to the top of the bucket, and placed on top of the fifty-five (55) gallon barrel at the back edge, which is the edge furthest away from the start and finish line. One (2008) white golf ball placed on the sand in the center of the bucket for each contestant.

One 30-gallon barrel placed 20 feet from the start and finish line. This barrel is placed in line with and between the other barrel and the start and finish line. This barrel has an open top with the bottom cut out.

Judges

Two (2) judges, one (1) at each barrel. In addition to judging, they are responsible for placing the golf ball on the bucket and removing the golf ball from the goal barrel after each ride.

Penalties

A five (5) second penalty will be added to the rider's time for knocking over the fifty-five (55) gallon barrel or the golfette bucket.

Disqualification

Failure to pick up the golf ball.

Dropping the golf ball.

The golf ball touching the fifty-five (55) gallon barrel or the ground due to the horse or the rider.

Failure to deposit the golf ball in the goal barrel.

Failure of the golf ball to remain in the goal barrel.

Knocking over the goal barrel.

Poles

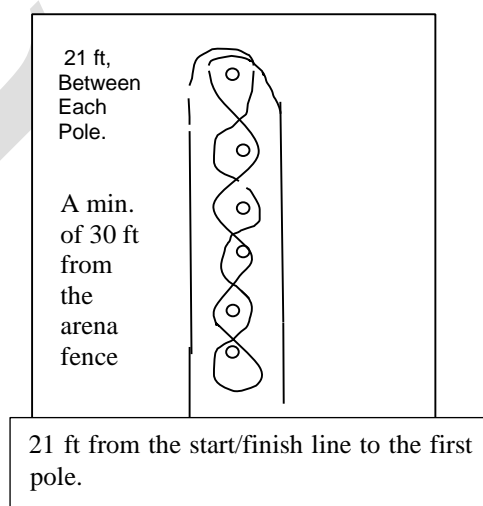

**** Riders can start from either the left or right side****

Description of Race

A horse may start either to the right or left of the first pole and then run the remainder of the pattern accordingly.

Equipment

Six (6) poles, which can be manufactured quarter horse poles, a minimum of 6 and ½ feet in height (2023). The bases should be a maximum of seventeen (17) (2015) inches in diameter with rubber hose covering the edge if metal discs are used. The maximum weight shall be twelve (12) pounds. The poles are to be spaced twenty-one (21) feet apart, the first pole being twenty-one (21) feet from the start and finish line. The pole pattern will not be set up any closer to the fence than 30 feet. 21 feet measurements are made from the center of the base of the pole.

Judges

One (1) judge at the start and finish line and as many judges as necessary to observe the pattern and to set up any poles knocked down. One (1) judge should be positioned to sight when repositioning poles.

Penalties

A five (5) second penalty will be added to the rider's time for knocking over a pole.

Disqualification

Breaking the pattern, such as failure to weave all the poles or properly correct the pattern.

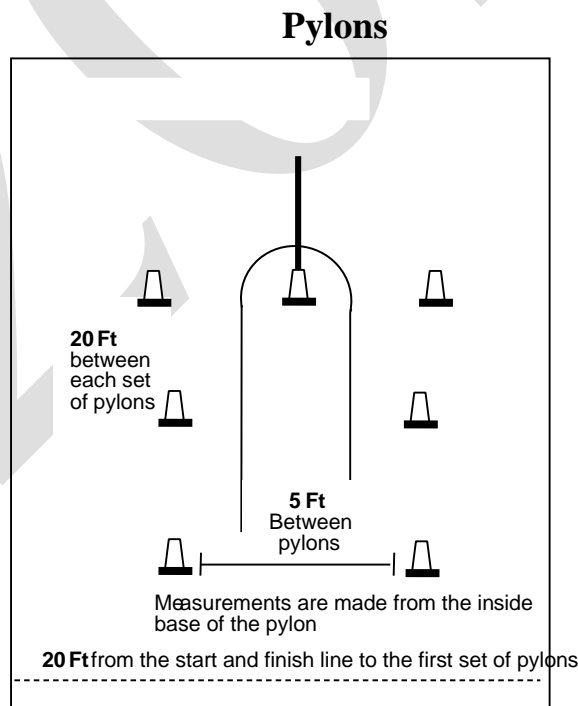

****Riders can start from either the left or right side****

Description of Race

The horse and rider must go between all pylons turning either to the right or left and going around the center pylon pole. The center pylon pole may be steadied. Then the rider must run the remainder of the pattern accordingly.

Equipment

Seven (7) highway type pylons (Saf-T-Cones), 18 to 28 inches in height placed 20 feet apart. The first two pylons are twenty (20) feet from the start and finish line and five (5) feet apart as measured from the inside base of the pylons (see diagram above). The last two (2) pylons are five (5) feet from the center pylon as measured from the inside base of the pylons. The center pylon has a maximum base size of seventeen (17) inches, contains a seven (7) foot pole, and weighs a maximum of twelve (12) pounds. Measurements are to be made from the inside base of the pylons and from the pole base (2017)

Judges

Two (2) judges to observe the pattern, at the back of the pattern (2022), and set up the pylons in their proper place if they are knocked over.

Penalties

A two (2) second penalty for knocking over a pylon or the center pylon pole.

Disqualification:

Breaking the pattern

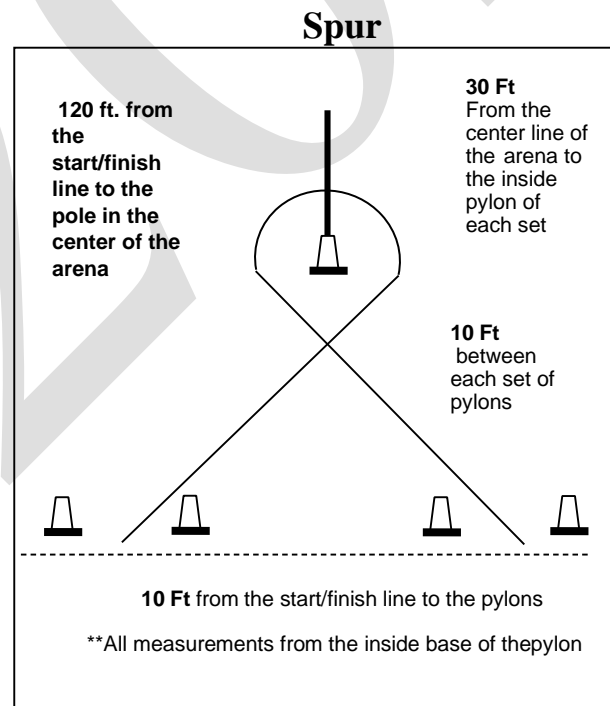

****Riders may start on either the right or left side****

Description of Race

The horse and rider must go through the first set of pylons, make a three hundred sixty (360) degree turn around the pole, returning through the second set of pylons. A right or left-hand pattern may be run.

Equipment

Five (5) highway type pylons eighteen (18) to twenty-eight (28) inches in height. The center pylon should have a maximum base size of seventeen (17) inches, contain a seven (7) foot pole, and weigh a maximum of twelve (12) pounds. The center pylon is placed one hundred twenty (120) feet from the start and finish line and is centered in the arena. Two (2) gates are formed one on each side of the arena with two (2) pylons used to form each gate. The pylons forming the gates are to be set ten (10) feet apart, ten (10) feet from the start and finish line, and thirty (30) feet from the centerline of the arena to leave sixty (60) feet between the set of pylons. All measurements are to be made from the inside base of the pylons.

Judges

Two (2) judges to observe the pattern and to reset the pylons in the proper place, if they are knocked over.

Penalties: None

Disqualification:

Breaking the pattern.

Knocking over any equipment

Texas T-Removed from Rule Book (2023)

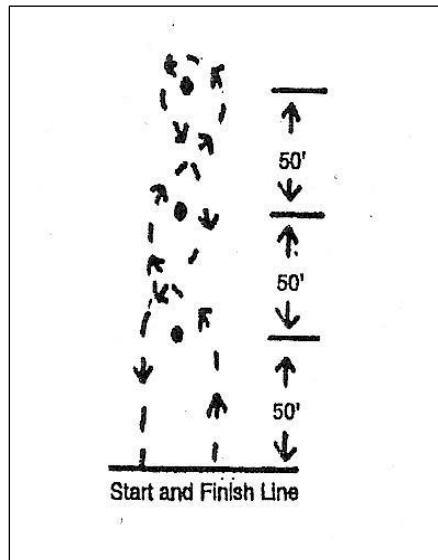

****Riders may start on either the right or left side****

Description of Race:

This is a timed event. Rider crosses timer line weaving either right or left of first barrel, continuing weaving in and out to the third barrel, 360 degrees turn around third barrel, then weaves back thru barrels to cross the timer line.

Equipment

Timer line (designates the beginning and end of each race marked by chalk or lime).

Three (3) 55-gallon standard oil drums with the dimensions being 23 inches from outside to outside on the ends and 34-1/2 inches long from the outside lip on top to the outside lip on bottom, placed (50) feet apart and third barrel 150 feet from timer line. Barrels must have barrel protectors.

Judges

Two (2) judges to observe the pattern and set-up the barrels and place in their proper place, if they are knocked over.

Penalties

A five (5) second penalty for knocking over barrel.

Disqualifications

Breaking the pattern

Failure to complete the race.

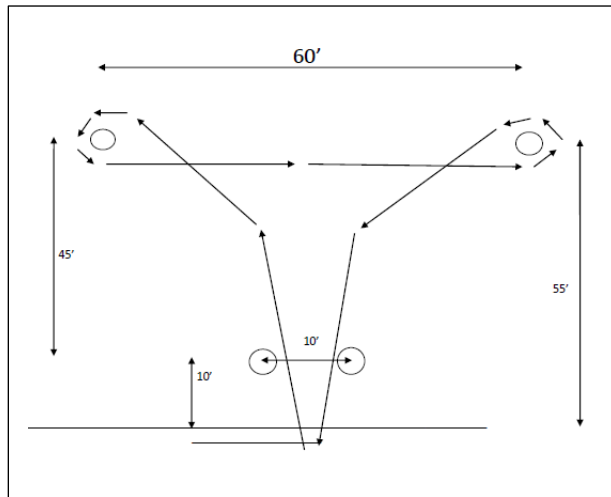

****Riders may start on either the right or left side****

Description of Race

Rider crosses timer line going between the first two (2) poles. Proceed to the next set of poles, either to the right or left pole. Going to the inside of the chosen pole, make a 360 degree turn around the pole. Proceed across the arena to the opposite pole and make same (right/left) 360-degree turn, finishing on the inside of the pole. Finish the pattern by going back through the first two (2) poles to the finish line.

Equipment

Four (4) standard poles

First two (2) poles are ten (10) feet from the starting line ten (10) feet apart, measured from the center of the poles and the center of the arena. Second two poles are fifty-five (55) feet from the starting line and sixty (60) feet apart, measured from the center of the poles and the center of the arena.

Judges

As many judges as necessary to observe the rider's pattern and to set up the equipment in the proper place if they are knocked over.

Penalties

There will be a five (5) second penalty for knocking over a pole.

Disqualifications

Failure to run a correct/complete pattern will be a disqualification.

Larryette

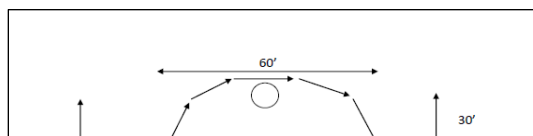

****Riders may start on either the right or left side****

Description of Race

Rider crosses the timer line either to the right or left set of poles. Rider goes on the outside of the first pole, inside the second, outside the third. Going around the barrel, rider proceeds to the second set of poles, going outside the first, inside the second and outside the third and crosses the finish line.

Equipment

Six (6) standard poles

One (1) fifty-five (55) gallon barrel with barrel pad

Poles are thirty (30) feet between each going down the arena.

Poles are sixty (60) feet apart across the arena.

Barrel is centered in the pattern and thirty (30) feet from the last poles.

Judges

As many judges as necessary to observe the rider's pattern and to set the equipment in the proper place if they are knocked over.

Penalties

There will be a five (5) second penalty for knocking each pole or the barrel.

Disqualification

Failure to run a correct/complete pattern will result in disqualification.

1. In team events, a team is considered as one participant.
2. A team member competing in one event cannot participate with a second team in the same event at any National Event. Team events will be considered a separate competition.
3. Participants in the team events shall be divided into eight classes:

Classic	Super Senior
Senior	Intermediate
Junior	Pee Wee
Mini Pee Wee	Assisted

4. An individual may change classes to form a team for team events. If the riders are in different age groups; (2018) the team must move up to the highest age group of the oldest rider, up to Seniors. Super Seniors or Classics must move down to the Senior Class if one of the riders are less than Super Senior or Classic age. Team riders can team up with a rider from another district for team events at finals. Only under extreme circumstances (such as a rider not able to ride) will you be able to change partners with the approval of the rules committee at finals (2012). The team events will be open in class (example: a Super Sr. Women can ride with a Super Sr. Man).
5. While each rider is competing, the next rider must be prepared for competition or the three (3) out count will be in effect. With the one riding and at least one in the gate. No other horses are allowed in the arena during a ride at finals. Only one (1) rider in the starting area at a time, except for your team partner. There will be a gate judge to regulate riders coming into the arena. The gate judge will enforce this rule at the National Playday Finals.
6. Once a rider starts his/her pattern, no assistance will be allowed by anyone inside the arena who is on the event side of the Start/Finish line. The only exception is in Relay, where Mini Pee Wee and Pee Wee horses can be held in the center of the arena until the pattern starts. The responsible person assisting the child must stay in the arena until the class is over.
7. At any time, if a rider falls or becomes dismounted in any race, except the rider being rescued in the Rescue Race, that person is disqualified.
8. A horse may be ridden only one time in each class or event except for a horse used by a family. Two brothers or sisters may ride the same horse in all events, but a horse may not

rider. The use of a back gate is suggested for the second rider to use to enter the arena. Circling the barrel is permitted.

Equipment

Two (2) pylons placed twenty-five (25) feet off of the fence on the start/finish line. Two (2) more pylons placed (25) twenty-five feet off of the fence on a line no more than one hundred eighty (180) feet from the start/finish line and not less than forty (40) feet from the back of the arena. A fifty-five (55) gallon barrel is then placed in the center of this area, to be equal distance from the star/finish line and the back line and equal distance from the side fences.

Judges

Two judges, one at the gate and one in the arena. The gate judge is responsible for ensuring that the first rider enters the pattern with the flag and that the second rider crosses the line with the flag. The second judge is responsible for ensuring that the second rider does not cross the back line before the first rider has deposited the flag in the bucket and ensuring that neither rider breaks the pattern.

Penalties: None

Disqualification

Breaking the pattern. Knocking over the barrel or bucket. Failing to deposit the flag in the bucket. The first rider crossing the wrong side of the pylons (2023). The second rider crossing the back line before the first rider has deposited the flag in the bucket. Failing to finish the pattern with the flag.

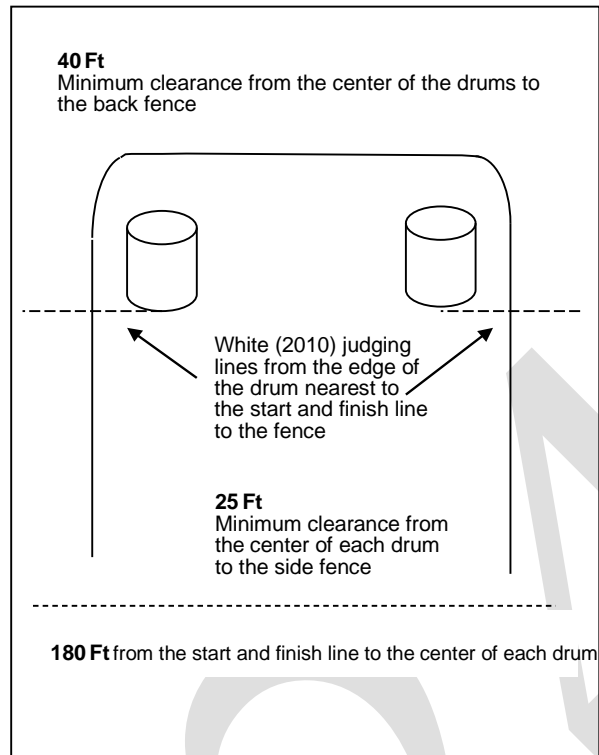

Description of Race

Each team is composed of two (2) riders on horseback. One (1) rider carrying the baton starts the run from the start and finish line. The baton is exchanged at the end of arena. The first rider hands off to the second rider who is stationed behind the drums. Both riders must go around the second drum. The second rider races on across the start and finish line and must be ahead of the first rider. The rider receiving the baton must be behind the drum when the race starts and remain there until the hand-off is made.

Equipment

Two (2) weighed plastic drums placed one hundred eighty (180) feet from the start and finish line and each set in twenty-five (25) feet from the fence line. The two (2) drums must be a minimum of forty (40) feet from the end of the arena. One baton of semi-rigid material eighteen (18) inches in length. A white (2010) judging line across the arena one hundred eighty (180) feet from the start and finish line on the edge of the drum nearest to the start and finish line. The use of a helmet is encouraged.

Judges

One Judge at the start and finish line and one judge at the back of the drums to watch the exchange of the baton and the rider's pattern.

Penalties

A five (5) second penalty will be added to the rider's time for knocking over or steadying the drums.

Disqualification

Dropping the baton. Exchanging the baton outside the hand-off area. A rider other than the second rider crossing the finish line first. The relay baton must be exchanged behind the judging chalk line (at the drums). The baton cannot come out of the hand-off area until the hand-off is made. Failure of either rider to follow pattern. Throwing the baton. The rider who receives the baton not being behind the drum when the race starts. The baton not being exchanged behind the white (2010) judging chalk line (at the drums).

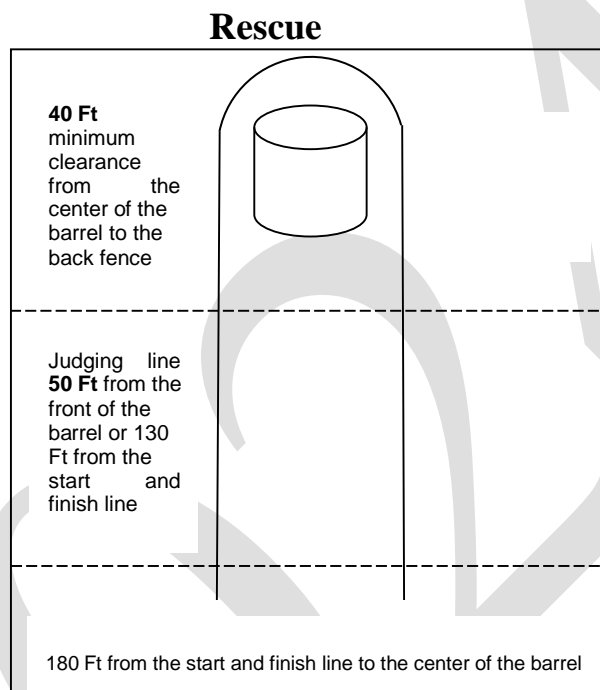

Description of Race

The race involves one person on horseback "rescuing" another on foot. The contestant on foot stands at the barrel waiting to be rescued. Mini Pee Wee, Pee Wee, Super Senior and Classic classes may stand on top of the barrel, if so desired. The contestant on horseback races from the start line, circles the barrel from either direction and races for the finish line. The contestant on horseback may help pull the other contestant up on the horse behind the rider. Both contestants must be astride the horse's back-knee being over the center line of the horse's back - before crossing the judging line and remain astride the horse's back until across the finish line.

Equipment

One (1) fifty-five (55) gallon barrel placed one hundred eighty (180) feet from the start and finish line. A judging line is marked across the arena fifty (50) feet from the front of the barrel or one hundred thirty (130) feet from the start and finish line. The drum must be a minimum of forty (40) feet from the end of the arena.

Judges

One (1) judge at the start and finish line and two (2) judges at the judging line on opposite sides, observing the pattern, and making sure both contestants are astride the horse.

Penalties

A five (5) second penalty will be added to the rider's time for knocking over or steadying the barrel.

Disqualification

Failure of both contestants to be astride the horse's back-knee being over the centerline of the horse's back - before crossing the judging line and remaining astride the horse's back until crossing the finish line. The rescued rider must be behind the rider and not in front of the horse's neck. No hand holds, or ropes tied to the saddle horn shall be used.

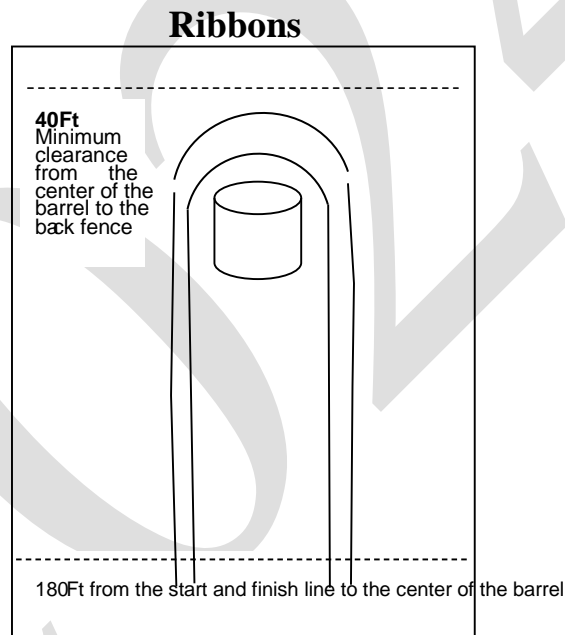

Description of Race

Two (2) team members, mounted on separate horses, and each holding opposite ends of the ribbon by one hand, race to and around the barrel and return to the finish line. The time starts when the first horse crosses the start line and stops when the first horse crosses the finish line. The riders may run either a right or a left pattern. Both riders must cross the start and finish line holding onto opposite ends of the ribbon.

Equipment

Ribbon, which will be a strip of crepe paper the nearest to two (2) inches wide, that is available, and 4 (four) feet long. One (1) weighted plastic barrel placed one hundred eighty (180) feet from the start and finish line or a minimum of forty (40) feet from the end of arena, on a line

down the center of the arena. A minimum of three (3) foot chalk line at the timer from the fence towards the center of the arena, to assist the judge (2023). The use of a helmet is encouraged.

Judges

Two judges at the start/finish line and one judge at the back of the barrel and as many judges to properly observe the pattern and issue ribbons to the contestants.

Penalties

A five (5) second penalty will be added to a rider's time for knocking over or steadying the drum.

Disqualification

Breaking the pattern. Dropping or breaking the crepe paper.

Attaching the horses in any manner except by riders holding the ends of the crepe paper. No deliberate touching of any kind allowed. Deliberately twisting, shortening, or manipulating the ribbon for strengthening the crepe paper.

Harry Larry

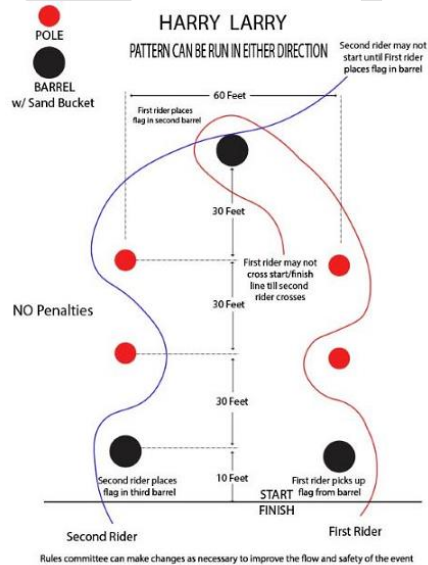

Description of Race

The race may begin on either side of the arena thus finishing on the opposite side of the pattern. Each team is composed of two (2) riders on horseback. One (1) rider will pick up the flag, on the external side of the barrel, after crossing the start and finish line. The same rider will weave the next two (2) poles and deposit the flag into the bucket placed on top of the barrel by going by the external side of the barrel. The retiring rider may go to the back of the arena or to the

internal part of the pattern. The next team event rider may not start until the first riders places the flag into the bucket on the barrel. The next team rider will pick up the flag from the external side of the barrel and begin weaving from the outside of the pole to the next pole and place the flag inside the bucket from the external side of the barrel and then finish the run by crossing the start and finish line. The second team rider must cross the finish line first.

Equipment

Three (3) fifty-five (55) gallon barrels. One barrel is placed one hundred (100) feet from the start and finish line, in the center of the arena. Another barrel is placed thirty (30) feet to the left of the center and ten (10) feet from the start and finish line. The third barrel is placed across from the second barrel, sixty (60) feet away and ten (10) feet from the start and finish line.

All barrel measurements are from the center of the barrel.

Four (4) standard poles with bases are placed per the diagram. One pole is thirty (30) feet from the barrel. Another pole is thirty (30) feet from the other barrel. Another set of poles are placed thirty (30) feet from the previous poles, per the diagram.

One standard flag (same dimensions as used in the Single Event Flag race.

Judges

One Judge at the start and finish line and one judge near the peak of the deposit barrel to ensure the pattern is ran correctly and the flag deposited, picked up and deposited per the event description.

Penalties

None:

Disqualification

Failure to complete the pattern, pick-up, deposit, pick-up and deposit per the patterns image and description of the event. The second rider must cross the finish line first.

The Rules Committee can make changes, as necessary, for this event, to improve the flow and safety of the event.

Team Flags

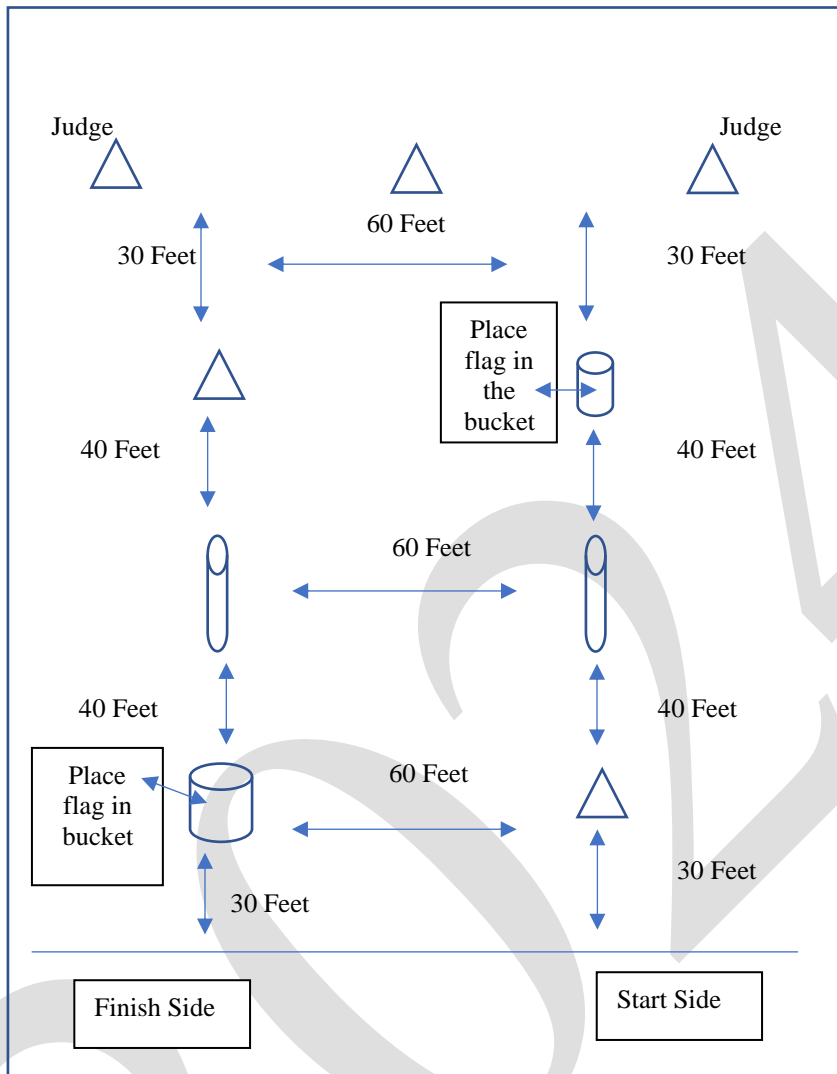

Description of Race: First Rider always starts on the right side but may go on either side of the first pylon. Enter the pattern and weave through the pylon, pole, and barrel. The first rider places a flag in the bucket, full of sand, on the barrel. The rider is not required to weave the final pylon. When the first rider's horse's head reaches the last pylon, the second rider enters the left pattern. The rider is not required to weave the first pylon. The rider will weave the second pylon, pole, and barrel. The second rider places a flag in the bucket, full of sand, on the barrel. The second rider places a flag in the bucket, full of sand, on the barrel.

Equipment: 2 standard size poles, 2-55-gallon metal barrels with protective barrel pads, 2 standard size flags and buckets, 4 standard size pylons

Judges: Two (2) judges to observe the pattern and to reset the equipment in the proper place if they are knocked over.

Penalties: None (2022)

Disqualifications: knocking over any equipment or failure to deposit the flag or breaking and not correcting the pattern (2022).

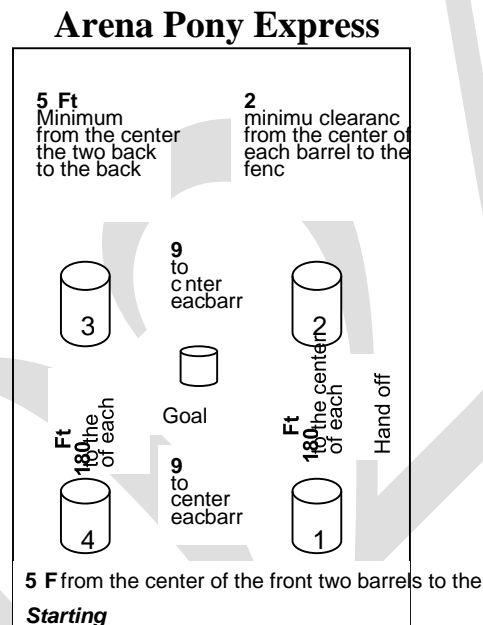

A. Arena Pony Express Races are run inside a closed arena. The race is run in a counter-clockwise direction with the fence being the outside boundary and four markers designating the inside of the lane. These markers must be at least thirty (30) inches in height. Plastic fifty-five (55) gallon drums are preferred with at least two (2) inches of sand or water as ballast. The inside markers should be one hundred eighty (180) feet apart on the long side and ninety (90) feet across the ends. This should leave at least twenty-five (25) feet running room between the markers and the sides and at least fifty (50) feet at the ends.

B. The foregoing paragraph is for the official arena size, but the races may be run in smaller arenas if the team captains are consulted by the host and ground rules are set.

C. The goal is a drum or barrel twenty-two (22) inches in height placed in the center of the four (4) markers near the middle of the arena. It is suggested that a regular thirty (30) gallon drum cut off to twenty-two (22) inches with at least two (2) inches of sand as a ballast be used. The goal barrel must have a bottom in it.

Player Eligibility

A. Teams shall be made up of riders from any club that is affiliated with the NARC & SP. All members of the team must be members in good standing of such club. Entry fees and rosters for National Pony Express Finals are to be turned into the National Pony Express Chairperson ten (10) days before the event.

B. The classes for this competition shall be:

Open: Who must be age 15 or over. They may be men, women, or mixed.

Juniors: Must be 15 or under with a non-riding adult captain.

Timed: There is no minimum age for a senior time team (2012).

C. To qualify to ride for a team at Pony Express Finals, a rider must appear on that team's roster three times during the qualifying tournaments. All teams must compete in all but one tournament to be eligible to compete at Pony Express Finals. Team captains will turn in their rosters to the National Secretary or an appointed person during or immediately following the captain's meeting.

D. Each District will be allowed to send as many teams as possible in each class to Pony Express Finals.

E. All brackets must have two teams to compete in a tournament, with the exception of the junior class.

Equipment

A. Two sets of saddlebags, each of different color, are to be used the same as the baton in relay race is used. These bags should not be less than seven (7) by eight (8) by thirty (30) inches nor larger than ten (10) by twelve (12) by thirty-six (36) inches and should weigh two and one-half (2-1/2) to three (3) pounds each. Snaps or zippers should be used, buckles will not be permitted.

B. The head judge will be mounted and equipped with a whistle, with which to start and stop the race.

C. Neither the horse nor rider shall use any unnatural or artificial equipment such as hot shots, buzzers, or any item other than riding equipment, which should be regular western gear.

D. The use of helmets is encouraged.

Teams: Timed class shall consist of 8 people with 2 being substitutes. Open class shall consist of 9 people per team with 7 people riding and 2 substitutes. In case of an accident, a substitute rider and/or horse will continue the game.

Description of Race

A. Prior to the start of the race, the first rider of each team will enter the arena. It is the responsibility of these first two riders and the starting judge to get the horses off to a fair and equal start within the vicinity of the Number 1 marker. The method of starting shall be discussed in a ground rule meeting of the team captains prior to the start of the race or tournament. The starting judge is responsible to recall the starting riders if either gets an unfair start. The judge may solicit help of the announcer to recall the riders.

B. The first riders complete their counterclockwise runs around the four markers returning to the Number 1 marker and handoff to their second riders between the fence and the goal barrel limited by the Number 1 marker and the Number 2 marker. The rider handing off will exit from the pattern by turning to the middle of the arena before the rider gets to the Number 2 marker. It is a disqualification if the exchange is not made, or if the rider handing off does not turn inside the Number 2 marker. The rider is not blocking as long as the rider maintains this course. It will not be a disqualification to pitch the saddlebags while making a hand-off.

After the retiring rider has brought the horse under control in the inside area of the arena, the rider will retire from the arena upon the exit judge's signal.

Each rider must follow the pattern of the starting horse except the last rider who, upon completion, will put the bag in the goal barrel.

C. It is the responsibility of the retiring rider not to interfere with the competing horses. The rider should leave the arena behind the running horses, not in front of them.

D. If a rider runs inside any marker or breaks the pattern in any way, the rider must correct the pattern before the rider continues the race; or the rider will be disqualified. If a rider drops the saddlebags, the race continues. The bags are to be recovered cautiously, without blocking, by the rider who dropped the bags.

E. If a horse or rider falls in the arena during the race, the race and/or clock will be stopped for the safety of both horse and rider.

F. If the race is stopped the judge shall start the race at the point where the riders were located when the race was stopped.

Protests

Protests are not allowed. The judges' ruling is final.

Disqualification

A. Defensive blocking is a disqualification. Defensive blocking is to place yourself and your horse in such a position as to obstruct your opponent when you are not effectively pursuing your course. Offensive blocking, when you are in the act of running your pattern, or handing off, or receiving the saddle bags is legal if you are moving forward in the process of running your pattern. If you are ahead of your opponent, you may at your own risk, run a close pattern, even though you crowd your opponent into the marker.

B. Judges may disqualify riders for use of profane language, fighting, or disorderly conduct of any kind. The use of alcohol is justification for disqualification. If, in the judge's opinion, any rider flagrantly disobeys any rule, the judge can, at the judge's option, expel any rider for the remainder of the year.

C. The striking of a horse (yours or an opponent's) with any equipment including saddlebags, quirts, bats, or reins inside the arena is a disqualification.

D. No rider is permitted to handle an opponent's equipment in any manner.

E. Not correctly completing the pattern is a disqualification.

F. Any rider who interferes with an opponent's horse, either by getting in the opponent's way or by placing the horse in such a position as to cause an opponent's horse to try to follow out a gate, is disqualified.

G. Deliberately kicking the barrels or handling of the barrels by a person with their hands is a disqualification, including the goal barrel.

H. A rider circling to the right in the running area is disqualified, except the last rider after reaching the goal barrel.

I. A retiring rider must leave the arena upon the exit judge or official's signal.

J. If the outside horse pushes the inside horse inside any corner barrel and goes in also, the outside horse shall be disqualified.

K. If a team does not have a complete roster at the start of the first race, they will be disqualified for that race and for all races thereafter for which they do not have a full roster.

L. Running the horse through the entry gate will be cause for disqualification.

Officials

A. Judges - Each race shall have four judges, with all judges wearing identifying vests. The Head Judge will be the starter and will watch for incorrect patterns and hands-off out of the hand-off zone. Judges will be paid an amount at the committee's discretion.

The second judge will work in the vicinity of the Number 2 marker and will watch for all rule violations. This judge will be primarily responsible for observing for the completion of the hand-off and turning of the riders. Both the head and second judges will be mounted and equipped with whistles.

The third judge will be the exit judge. This judge will signal the retiring riders when to exit the arena. This judge will be on foot. The exit judge will be the #2-barrel setter located at the end of the hand off area. This judge is optional and can be substituted with an exit official.

The fourth judge will be the entrance judge. This judge will signal riders when to enter the arena to run their races. This judge will be on foot. This judge is optional.

B. Recorder- The recorder shall keep the bracket and record the winner and loser of each race. The recorder shall at all times know which teams will start running, which bag each is carrying, and in which lane each team is running. The recorder will inform the announcer of the winner as soon as the judge declares the color of the winning bag.

C. Announcer - The announcer will keep the games rolling but must not talk excessively. The announcer must take the information from the recorder and announce the winners. The announcer should not make any decisions before the officials and judges declare them.

D. Pony Express Committee - The committee will handle all disorderly conduct inside and outside the arena at the tournaments. The Pony Express Committee has the right to modify the pony express rules, with a two-thirds (2/3) majority of the committee present, for a given tournament as emergency situations arise.

Brackets

The teams will run a round-robin bracket in which every team runs every other team.

The team with the greatest number of wins is the tournament winner. In case of a two-way tie, the team that won the race between the tying teams will be the winner. In case of a three-way tie, if each of the three teams beat each other, there will be a draw for a bye, and a run-off for the three places involved.

The winner of each Pony Express race is determined by the final rider who deposits his/her bag in the goal barrel first, unless his/her team is disqualified by the judges, or the rider knocks over the goal barrel and the bags fall out. If the latter should happen, the judge shall set the goal barrel

up right. If the bag goes into the barrel and does not hang up or remain on the ground, the first bag in is the winner.

The winner of the Timed and Junior teams will be determined by the lowest time. Race times will be totaled with disqualification being an automatic ten (10) minutes.

Awards

The National Champion will be the team who wins the final tournament.

Drill & Parade Competition Rules

Qualification

In order for Drill Team points to count towards the end of the year awards, all riders must participate. Time and place for all are to be decided by the National Parade and Drill Committee.

Classes

The classes for this competition shall be separated into Junior and Senior Drill Teams. A team shall consist of a minimum of 4 riders. A Junior team shall consist of riders ages 16 and under with up to (2008) 25% of Senior riders. A senior shall be any age. A maximum of four alternates may participate in the grooming competition at the finals to be eligible for an award. The current year drill committee has the power to determine the classes that will be done at that year's competition. This will be determined before the first competition of the year (2011).

Drill Points

A maximum of two hundred fifty (250) points shall be awarded by each judge distributed as follows:

- A. Unit appearance shall have a maximum judging score of sixty (60) points divided into three (3) categories as follows:
1. Uniformity of Unit – maximum 20 points.
 2. Rider and Attire - maximum of 20 points.
 3. Horse and Tack - maximum of 20 points.

The same attire/tack must be worn by rider and horse during the grooming and drill competition in all National Association Drill Competitions. Props and/or special riders/mascots will be decided upon by the National Association Parade and Drill Committee.

B. Quality of drill shall have a maximum judging score of one hundred ninety (190) points divided into eight (8) categories:

1. Entry - Shall have a maximum of ten (10) points allowed and judged as to the manner in which the team enters the arena.
2. Difficulty - Shall have a maximum of twenty-five (25) points allowed and judged as to the difficulty of the maneuvers during the drill.
3. Precision - Shall have a maximum of thirty (30) points allowed and judged as to the timing, spacing, etc.
4. Horsemanship - Shall have a maximum of forty-five (45) points allowed and judged as to the ease and control of the entire unit.
5. Continuity - Shall have a maximum of thirty (30) points allowed and judged as to the ease of changing from one maneuver to another for continuation of maneuvers during a performance.
6. Originality - Shall have a maximum of twenty (20) points allowed and judged by the type of maneuvers performed.
7. Showmanship - Shall have a maximum of twenty (20) points allowed and judged by the action and courtesies shown by the participants toward all viewers of the performance.
8. Exit - Shall have a maximum of ten (10) points allowed and judged for the manner in which the team leaves the arena.

Judges

A. The committee will select a minimum number of impartial judges (2017). Possible sources for judges include the AASP & RC, The Moslah Shrine Patrol, The Hella Temple Shrine Patrol, the AQHA, and the NARC & SP (Mini-Comps only).

B. No National Association members will be used as judges for Parade and Drill Finals.

C. It is suggested that the judges start each team with approximately 75% of the maximum point allowed in each category and grade up or down to arrive at their conclusion for the unit score.

D. In the judging of unit appearance, it is suggested that each team enter and assemble in an orderly manner for the judges to score.

E. Judging sheets will be available for fifteen (15) minutes after the mini-competitions and the finals.

F. Each team will use a standard black number on a white background and be a minimum of six (6) inches. (2010)

Time Limits

Time limits for the competitions will be set as follows:

Each drill team shall have a maximum of fifteen (15) minutes in which to perform their drill. Any team violating the time limits will receive a five (5) point deduction for each full minute in violation of the time rule. Deductions will be made from the final score.

Activity Points will be awarded as follows:

A. Activity points will be accumulated from October 1st to October 1st . One (1) point will be given to any club which has a minimum of six riders in uniform for participating as a club in any rodeo, parade, playday, or drill competitions.

If the team places in any of the above functions, an additional 5 points will be given for First, 4 points for Second, 3 points for Third, 2 points for Fourth, and 1 point for Fifth place.

A list, including what activity the team performed, when the activity took place, and the number of points accumulated for the activity will be turned in at the October Convention to the Parade and Drill Chairperson.

B. A high point trophy will be given at the January Convention for the team with the most points earned over the year. Each club secretary will report points to their District Parade and Drill Chairperson and that district representative will report to the National Parade and Drill Chairperson.

Parade Competition Rules

A. A group shall consist of not less than six riders to receive points in a NARC & SP sanctioned parade. Only one (1) class shall be judged.

B. Any NARC & SP Member Club who participates in any parade will receive points toward the NARC & SP trophy. The points will be as follows:

First Place - 5 points

Second Place - 4 points

Third Place - 3 points

Fourth Place - 2 points

Fifth Place - 1 point

C. A club shall be judged on behavior of horses, rider, general appeal, showmanship, and attractiveness of the entire group. Each horse should be properly groomed, feet trimmed, body brushed and clean, mane neatly roached or combed and tail properly pulled and combed. Tack and gear shall be clean and in good repair and shall match the rest of the group.

Parade Ethics

The American Flag takes precedence over all other flags. State flags take precedence over all club flags. When carried together, the American Flag should always be on the right, and the State flag on the left. The same is true of State flags; they should be carried on the right of club flags. When carried single file, the American flag should lead, the State flag should be next, and the club flag last in order. In the case of the Association flags being carried in parades, it is the general practice for it to lead the parade behind the American and State flags or in front of the first mounted group. Sit straight in the saddle and keep the horse under control. Stay in line and keep the horses evenly spaced. Smoking and boisterousness are not considered the best ethics.

Miss NARC&SP Queen Contest Rules

I. Miss NARC & SP shall act as an ambassador of the NARC&SP at any and all playdays, parades, rodeos, and alike functions. Miss NARC & SP Queen should always present herself in a dignified manner in her personal attire and conduct. Miss NARC & SP shall be of high morals and possess leadership qualities. The Miss NARC & SP will reign from January 1 to December 31. The candidate selected as Miss NARC&SP shall be crowned at the annual October Convention dance.

II. Code of Conduct

Miss NARC&SP nor the Queen Contestants shall not participate in excessive displays of public affection while representing the Association at any function. The Queen nor the Queen Representatives shall not use foul or vulgar language. Queen nor Queen Representatives shall not use any tobacco products or alcohol while at a club, district or national function or while representing the Association at any other functions.

III. Qualifications for Miss NARC & SP

A. Contestants must be a paid member of the NARC & SP as of December 31 and the two years prior to the contest. All contestants shall be single, never before married, nor pregnant, nor have born a child and never charged or convicted of a crime. Contestants must be 15 years (2018) of age by January 1 of the reigning year and not more than 30 (2022) years of age as of January 1 of the reigning year.

B. The application deadline for Miss NARC & SP (2022) Will be decided on and published by the Queens Committee. The application and activity sheets must be turned in to the NARC&SP Queens Chairperson. If the application is mailed, please allow five (5) days for mail delivery. Regardless of how the application and activity sheets are delivered, they must be delivered by the deadline.

C. Activity sheets, along with her application, must be presented and signed by each contestant's District President, Club President and District Queen's Chairperson for verification of at least 50% participation in club and district activities in the competing year. She must have also competed in a District or Club Queen or Sweetheart completion.

D. A list of all contestants will be furnished to all members one (1) week after the entry deadline, by the National Queen Chairperson. All questions regarding eligibility of any contestant, morally or otherwise should be brought to the National Queen Chairperson within ten (10) calendar days of date of notice of contestants. All complaints will be investigated by the National Queen Chairperson with a report to be given to the National President, if action is necessary.

E. If the candidate is a student, her grades should be good enough to permit some absence from school. If the candidate is not in school, she must have graduated from high school or the equivalent.

F. It is suggested that an informational meeting be held for the parents and contestants prior to any appearance made as a Miss NARC&SP Queen Contestant. This informative meeting will go over expectations of contestants and rules of the contest.

G. Contestants will draw an identification number to be worn during the entire competition.

H. Queen Contestants cannot be introduced as a Queen Contestant until after June 1 deadline.

I. All contestants, excluding at the Queens' Playday, are to be introduced after all royalty and officers at NARC&SP events.

J. Contestants who are currently performing duties as a District or Club Queen/Sweetheart will not be introduced in that capacity at NARC&SP Events. They will be introduced as a Miss NARC&SP Queen contestant and acknowledged as representing their respective club or district. They shall not wear a crown or tiara on their hat. Contestants may not wear the NARC&SP colors consisting of white and gold worn together as an ensemble. Gold may only be worn as an accessory.

K. District queen chairpersons with contestants who are currently district queens or sweethearts will be responsible for identifying a substitute representative for all NARC&SP functions such as Queens' playday, Drill, and October Convention.

L. All contestants must wear a sash. Sash should not be over five (5) inches wide and thirty (30) inches long, white with black lettering. Sash shall read "Contestant".

M. The current Miss NARC&SP shall act as a host and example for the candidates for the next Miss NARC & SP. She shall write a letter to all candidates no later than fifteen (15) calendar days prior to the riding competition, outlining the activities of the contest and include suggestions as to the appropriate apparel.

IV. Attire

A. Under the supervision of the National Queens Chairperson, Miss NARC&SP shall wear complete western queen attire, such as a white and gold suit, western boots, and western hat when representing the NARC&SP at all functions including, but not limited to Conventions, Parades, Rodeos, Playdays, other promotional events and any other National event. Western queen attire is defined as a creased western hat, long sleeve, tucked in shirt, long pants, western boots, tiara, and sash. Neither blue jeans nor riding shoes will be allowed, as they are considered casual.

B. She must be introduced in full western Queen attire.

V. Duties of the Queen

1. Make open playdays with or without an invitation.
2. Always have her uniform available in case it is needed.
3. Make a personal reply to each invitation to make an appearance.
4. Have an article published in the Horsetales every month.
5. Be on time, at least 30 minutes prior to the start of the function.
6. Mix and mingle with Association members at any functions.
7. Coordinate appearances with the NARC&SP Wrangler and President prior to the date of the activities.
8. She is to keep a scrapbook of her activities.
9. Miss NARC&SP is a good-will ambassador for the NARC & SP and it is suggested that she make as many appearances as possible outside National functions, such as parades, playdays and other district or club sponsored events.
10. She must attend and compete in 75% or more National functions during her reign.
11. Extensive travel is required as Miss NARC&SP Queen's own expense. She should have access to all the equipment necessary to appear as a representative of the NARC&SP
12. Miss NARC&SP has voting rights.
13. It shall be the Miss NARC&SP Queen's responsibility to notify the National Queen's Chairperson in the event she is unable to serve at any function. The Chairperson, in turn, will notify the First Runner-up to fill in. When the First Runner-Up represents the NARC&SP, she will be held to the same standards and rules as the reigning Miss NARC&SP.

14. The immediate past Miss NARC&SP Queen shall be an honorary member of the Miss NARC&SP Queen Committee for a period of one year.

VI. The Miss NARC & SP contest shall consist of (2016):

1. Riding Competition, Grooming & Appearance-33 points
2. Personal Interview, Speech & Impromptu Questions-33 points
3. Delegate Vote – 34 points

A. Miss NARC&SP shall be selected by a panel of at least four judges who shall have no connection with the NARC& SP or any member club. The National Queens Committee shall appoint the judges.

B. Each category (#1 & # 2 above) must be judged by at least two judges.

C. The riding competition should be held prior to the Queen's Playday or not later than two (2) weeks before the October Convention. There will be a personal interview by the judges at the riding competition. Each girl is to ride her own horse.

D. A 2-3 minute speech will be given at the October Convention in front of the delegates and judges.

E. Two (2) impromptu questions will be selected by the Queens Committee and asked to each candidate at the October Convention. One (1) question, submitted by each Queen Contestant, will be randomly drawn by the contestant herself and asked to that candidate at the October Convention. There will be a personal interview by the judges at the October Convention (2005).

F. Immediately following each phase of judging, the score sheets will be sealed in envelopes and signed by the respective judge and a NARC&SP Officer or Committee Chairperson. Point value per category will be determined by adding together the judges' points and dividing the number by the number of judges (2016).

G. The Miss NARC&SP Queens Committee, as a whole (District Committee members and National Chairperson), shall tally the judging sheets each year. In the case of a tie, the delegate's vote will be used to break the tie. These sheets shall be open to any member of the association to inspect the day after the crowning of the New Miss NARC&SP Queen.

H. At the October Queens Ceremony, Miss NARC&SP will be presented with the customary tiara and banner (which are passed down), award (2016), and a check for \$900. To cover the expense of her wardrobe. The First & Second Runner-up shall receive gifts (2016).

I. The new Queen shall receive her permanent items, tiara, banner, belt buckle, trailer signs, saddle pad cover, scrapbook, lettered saddle (optional 2016), breast harness, and headstall by January 1st of the year reigning, so she may represent the association (2018). At the January convention the Queen will display her saddle pad cover, scrapbook, lettered saddle (optional-2016), breast harness and headstall. The Queen shall have the option of a scholarship in lieu of the lettered saddle (2016). The current Queens Chairperson is responsible for getting all the above items for the new queen before leaving office December 31.

J. The NARC&SP is to buy a lettered saddle, if the option of the additional scholarship is not chosen (2016), breast harness, and headstall not to exceed a combined cost as determined by the budget and approved by the delegates. Miss NARC& SP's name shall be engraved on a nameplate attached to the saddle and not tooled into the leather.

K. The Queens Committee will award a \$1,000. (2002) scholarship to the Queen each year. The scholarship check will be made payable to the school of education of her choice. If the Queen is in high school, the scholarship will be available up to five (5) years after the completion of her reign (2015). If she is in college, the scholarship will be available up to five (5) years after the completion of her reign (2015).

L. In the event a member of the NARC&SP feels Miss NARC &SP, during her reign, has not or cannot fulfill her responsibilities, the member must first file a written complaint. Both the Club President and one other officer of the member club along with their respective district chairperson must sign the complaint. In turn, the District shall contact the National Queens Chairperson to call a special meeting of the entire committee. If the committee feels the complaint is valid, the National Queens Chairperson shall contact the NARC&SP President to request he or she call an executive board meeting for an investigation. In the event it becomes necessary to have Miss NARC&SP resign, it will be the responsibility of the National Queens Chairperson to dismiss her and notify the First Runner-Up to serve as Miss NARC&SP.

M. In the event Miss NARC&SP voluntarily resigns or is terminated from her office, all items issued to her will immediately be returned and become property of the NARC& SP. Miss NARC&SP must keep an itemized list of all wardrobe expenses along with all receipts of her wardrobe purchases. Any portion of the money that is not accounted for in the itemized list must be repaid to the NARC&SP within ten (10) calendar days after resignation or termination.

N. In the event of resignation or termination, the First Runner-up will be asked to assume the Miss NARC&SP responsibilities and acquires all items issued to the resigned or terminated Miss NARC&SP. The NARC&SP General Fund will provide an \$825. wardrobe allowance, a new banner, a new belt buckle and a new engraved saddle plate. The First Runner-up will be provided the customary tiara and banner (which are passed down), trophy, trailer signs, saddle

pad cover, scrapbook, stationary, permanent tiara, saddle, breast collar and headstall. Except for the items passed down, at the end of the year, these items belong to her.

NARC & SP Wrangler

A. The NARC&SP Wrangler shall be a male representative for the NARC&SP. The minimum age for the representative is fifteen (15) years old and a maximum of twenty-two (22) years old as of January 1st of the reigning year. All NARC & SP Wrangler contestants shall be single and never been married.

B. The NARC&SP Wrangler should be of high morals and encourage the motto of “Horsemanship, Sportsmanship, Hand N’ Hand”. The position should be held by someone that is willing and able to gain an understanding of the leadership and committees that make up the Association. The Wrangler office should be held by someone that presents himself in a dignified manner, in personal attire and conduct at all times. The representative is expected to be a member in good standing of a member club within the NARC & SP and have held a Wrangler position on a club or district level.

C. The Wrangler is to be part of and supervised by the National Wrangler Chairperson and committee.

Duties

1. Attend and promote playdays, parades, pony express, drill and all other activities of the NARC & SP.
2. Attend and vote at the January and October conventions as well as the Executive Board meetings throughout the year.
3. Carry the National Association flag at parades, grand entries, etc.
4. Place an article in the NARC & SP Horsetales’ as published.
5. Mix and mingle with Association members at any function.
6. Coordinate appearances with NARC & SP President and Queen prior to date of activities.
7. Notify the National Wrangler chairperson in the event he is unable to serve at any function or has two engagements on the same day.
8. NARC&SP Wrangler will escort Miss NARC&SP at the October Convention

E. Wardrobe

The NARC&SP Wrangler shall receive a check in the amount of \$400 for a wardrobe allowance. This allowance should cover the expenses of black boots, black jeans, a western hat, black vest or sports coat and a tie or scarf made up of the Association colors (black, gold and/or white). The Wrangler representative will receive a shirt, exact or similar in nature to the attire worn by the other officers of the NARC&SP. The above listed attire shall be worn by the

Wrangler representative at all important functions such as conventions, parades and other promotional events. Suitable attire for other appearances shall be under the discretion of the National Wrangler Chairman.

F. Wrangler Contest

Each Wrangler contestant shall turn in an application along with an activity sheet by June 1st to the National Wrangler Chairperson. Applications must be presented to contestants' club and district for verification of at least 50% participation in activities in the year competing. The application must be signed by his District President and District Wrangler Chairman. If there are no candidates to run for National Wrangler due to age, the committee can accept an application from a 14-year-old. The extended deadline would be June 15th. (2011).

G. The NARC&SP Wrangler shall be selected by a panel of at least four (4) judges who shall have no connection with the National Association or any member club. The judges of the Wrangler contest will base their scoring on a twenty (20) point maximum per category. Each category must be judged by at least two (2) judges. Categories being judged are riding, appearance and grooming, self-confidence, and speech. The fifth category is a popular delegate vote at the October Convention. The formula for calculating the popular delegate vote being the number of votes each contestant receives divided by the number of voting delegates multiplied by 20. For example: if there are 100 delegates and a contestant receive 62 delegate votes, then the calculation would be $62/100 \times 20$ or 12.4 points.

Immediately following each phase of judging the score sheets will be sealed in envelopes and signed by the respective judge and an Association officer or committee person. Point value per category will be determined by adding together the judge's points and dividing that number by the number of judges with a maximum of points per category as listed below.

NARC&SP Wrangler contest and score per category shall consist of:

1. Riding Competition, 0 – 20 points
2. Appearance & Grooming, 0 – 20 points
3. Self Confidence, 0 – 20 points
4. Speech, 0 – 20 points
5. Delegates Vote, 0 – 20 points

The riding competition should be held no later than two weeks before the October Convention. The Wrangler contestants will be judged on grooming, appearance, a reining pattern, speed events and arena work. Each contestant is to ride his own horse.

A 2 to 3-minute speech will be given at the October convention in front of the delegates and judges. Two (2) impromptu questions will be selected by the Wrangler committee and asked to each candidate. One (1) question submitted by each Wrangler contestant will be randomly

drawn by the contestant himself and asked to that candidate at the October convention. No candidates will be allowed to answer their own question. Contestant questions will be reviewed by National Wrangler Chairperson.

The NARC&SP Wrangler committee shall tally the judging sheets each year following the delegates meeting. In the case of a tie, the delegate's vote will be used to break the tie. These sheets shall be open to any member of the Association to inspect the day after the election of the new NARC&SP Wrangler.

At the October convention ceremony, the NARC&SP Wrangler will be presented with the customary hat pin (which is passed down), a check in the amount of \$400 to cover wardrobe expenses and any other awards budgeted and approved by the current Wrangler committee. At the January convention the Wrangler will be presented with a trophy belt buckle and saddle pad cover. The current Wrangler chairperson is responsible for getting all of the above items for the new Wrangler before leaving office upon January 1st.

The Wrangler shall receive a onetime \$500 educational or technical scholarship from the NARC&SP general fund for this position. The scholarship will be made payable to the school. If the Wrangler representative is in high school the scholarship will be made available for up to five (5) years after he graduates. The scholarship bylaws and rules will apply to the Wrangler representative.

In the event the representative cannot fulfill the year all provided items, financial and tangible, will be obtained by the committee chairperson and subsequently awarded to the interim replacement for use the remainder of the year.

Wrangler Code of Conduct

Wranglers shall not participate in excessive displays of public affection while representing the Association at any function. Wrangler representatives shall not use foul or vulgar language. Wranglers shall not use any tobacco products or alcohol while at a club, district or national function or while representing the Association at any other functions.

Rule Changes & Notes:
